

YAMAHA R-300

Natural Sound Stereo Receiver

Optical Balance Tuning

Continuously Variable Loudness Control

FM Muting

Speakers A, B, A + B Selector Switch

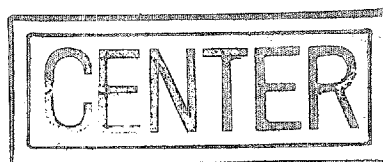

OWNER'S MANUAL



R-300

Thank you for purchasing the YAMAHA R-300 stereo receiver.

WARNING

To prevent fire or shock hazard, do not expose this appliance to rain or moisture.

IMPORTANT!

Please record the serial number of your unit in the space below:

Model: **R-300**

Serial No.

The serial number is located on the rear of the chassis.

Special Instructions for British Model

IMPORTANT!

The wires in the mains lead are coloured in accordance with the following code:

Blue: NEUTRAL

Brown: LIVE

As the colours of the wires in the mains lead of this apparatus may not correspond with the coloured markings identifying the terminals in your plug, proceed as follows. The wire which is coloured BLUE must be connected to the terminal which is marked with the letter N or coloured BLACK. The wire which is coloured BROWN must be connected to the terminal which is marked with the letter L or coloured RED.

CONTENTS

	Page
CAUTION: READ THIS BEFORE OPERATING YOUR R-300	2
CONNECTION DIAGRAM/REAR PANELS	3
CONNECTIONS	4/5
FRONT PANEL PARTS AND FUNCTIONS	6/7
LISTENING TO A PROGRAM SOURCE	8
TROUBLESHOOTING	9
SPECIFICATIONS	10
BLOCK DIAGRAM	11

R-300

CAUTION:
READ THIS BEFORE OPERATING YOUR R-300

1

The R-300 is a sophisticated stereo receiver. To ensure proper operating for the best possible performance, please read this manual carefully.

2

Choose the installation of your R-300 carefully. Avoid placing it in direct sunlight or close to a source of heat. Also avoid locations subject to vibration and excessive dust, heat, cold or moisture. Keep away from such sources of hum as transformers or motors.

3

Do not open the cabinet as this might result in damage to the set or electrical shock. If a foreign object should get into the set, contact your dealer.

4

Do not place records or other objects on top of the receiver so that the ventilation holes are blocked. This will cause the internal temperature to rise and may result in a failure.

5

When removing the power plug from the wall outlet, always pull directly on the plug; never yank the cord.

6

To prevent lightning damage, pull out the power cord and remove the antenna cable in case of an electrical storm.

7

Do not use force when using the switches and knobs.

8

When moving the set be sure to first pull out the power plug and remove cords connecting to other equipment.

9

Always set the volume control to "0" while lowering the tonearm to play a record, then turn the volume up after the stylus is seated in the record groove.

10

Do not attempt to clean the R-300 with chemical solvents as this might damage the finish. Use a clean, dry cloth.

11

Be sure to read the "troubleshooting" section for advice on common operating errors before concluding that your R-300 is faulty.

12

Keep this manual in a safe place for future reference.

13

(U.S., Canada & General models only) Do not connect audio equipment to the AC outlets on the rear panel if that equipment requires more power than the outlets are rated to provide.

14

Voltage Selector (General Model only)

The voltage selector switch on the rear panel of the R-300 must be set for your local mains voltage BEFORE plugging in the AC main supply. Voltages are 110/120/220/240 V AC, 50/60 Hz.

(Refer to Page 3.)

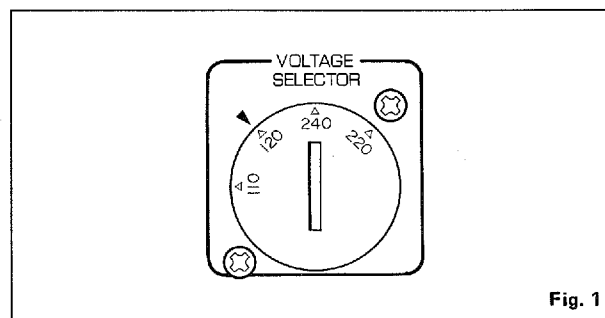

R-300 CONNECTION DIAGRAM/REAR PANELS

Be sure to connect the left (L) and right (R) channels consistently from component to component.

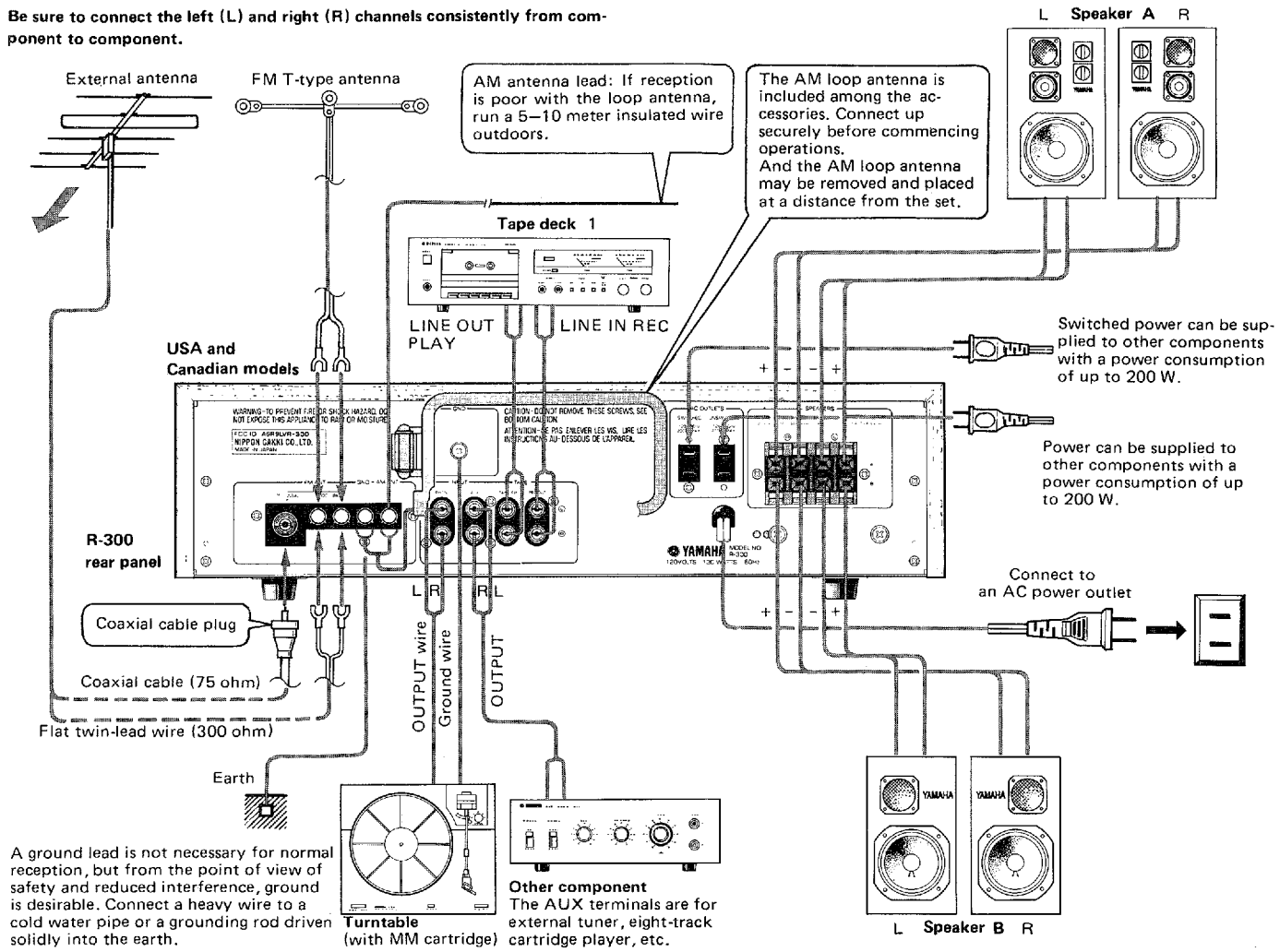

REAR PANELS

- General model

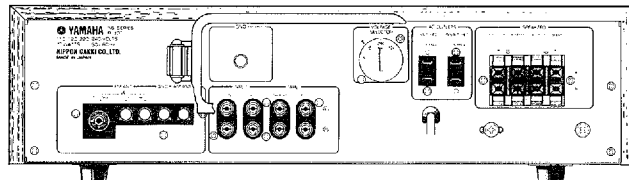

- British and Australian models

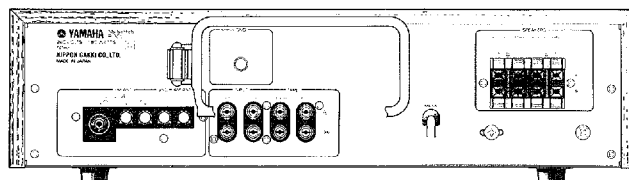

- North European model

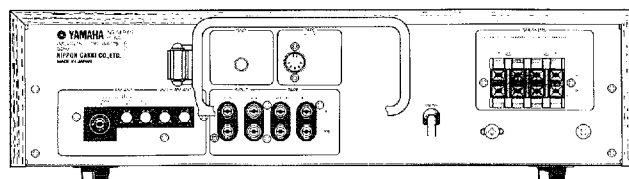

R-300 CONNECTIONS

55.12/26

■ CONNECTING THE SPEAKERS

The matching impedance of this amplifier is 8 ohms. Either one of two pairs of speakers may be connected. If only one pair is connected the recommended speaker impedance may be anywhere between 4 and 16 ohms. If two pairs are connected, however, it is advisable to use speakers with at least an 8 ohm impedance for optimum performance. Connecting two pair of 4 ohms speakers is not recommended.

Connect the cords going to the left speakers to the L terminals and the right speaker cords to the R terminals, making sure that the "+" and "-" markings are observed. If the "+" and "-" wires are reversed at either speaker, the sound will be unnatural and will lack bass. Speaker cords should be cut as short as possible; do not coil up excess wire on the floor. Also, do not bundle with cords from other system components.

Push in on the lever at the terminal, insert the exposed wire of the speaker cord into the hole and then release the lever. The cord will be locked into position. If these connections are faulty, no sound will be heard from the speakers.

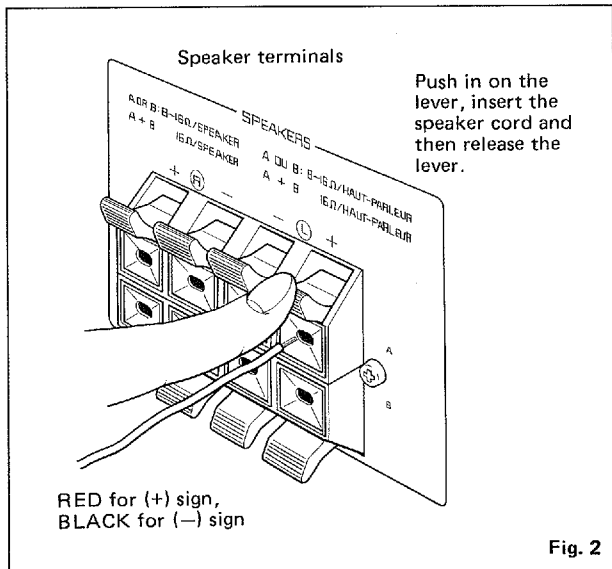

■ CONNECTING A TURNTABLE

Connect the output cords of the turntable to the receiver's Phono jacks, and connect the ground wire to the Gnd terminal. Normally, connecting the ground wire produces minimum hum, but in some cases better results are obtained with the ground wire disconnected. The cartridge and the turntable's output cords should be positioned well away from such sources of hum as power cords or power transformers of other system components.

■ CONNECTING A TAPE DECK

Connect the Tape PB jacks to the tape deck's Line Out jacks, and the Rec Out jacks to the tape deck's Line In jacks. (On North European models provide with the DIN connector.)

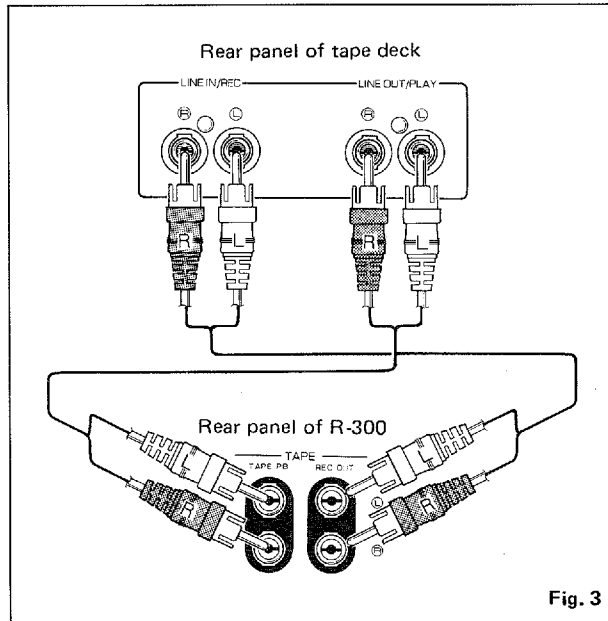

■ CONNECTING THE AM ANTENNA

In many cases it will be possible to get excellent AM reception with the attached AM loop antenna. Attach the antenna leads to the Gnd and AM Ant terminals and rotate the antenna in its bracket for best reception. The loop antenna may also be removed and hung on the wall.

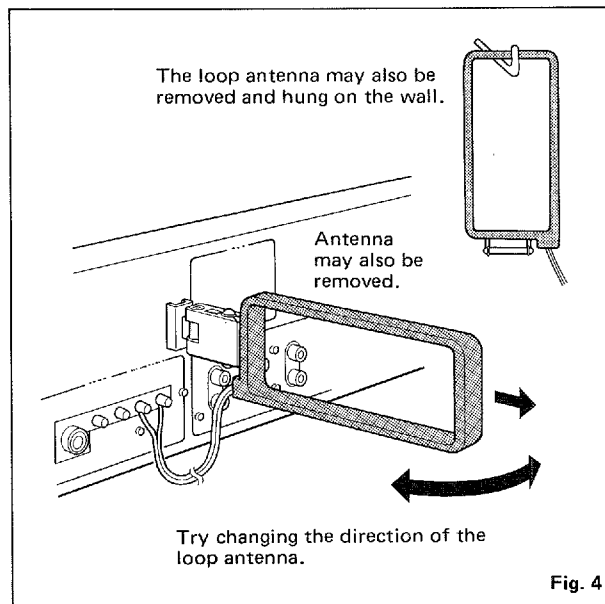

If necessary, an outdoor antenna may be used for improved AM reception. Connect a 5–10 meter length of insulated wire to the AM Ant terminal and run it outdoors.

■ CONNECTING THE FM ANTENNA

Choose an FM antenna that is appropriate to the local reception conditions. Consider the distance from the broadcast station and possible interfering objects such as surrounding tall buildings. In cases where there is a strong signal from a local station, a portable T-type antenna is usually adequate. Connect the feeder wire to the 300 ohm terminal, stretch the wire out tight, and turn to obtain optimum reception. Attach to a suitable support such as a wall.

In all but the best reception conditions, an outdoor FM antenna is necessary for best results. Either 300 ohm flat twin-lead wire or 75 ohm coaxial cable may be used. In locations where electrical interference is a problem, coaxial cable is preferable. Refer to fig. 5 for instructions on installing the coaxial cable plug.

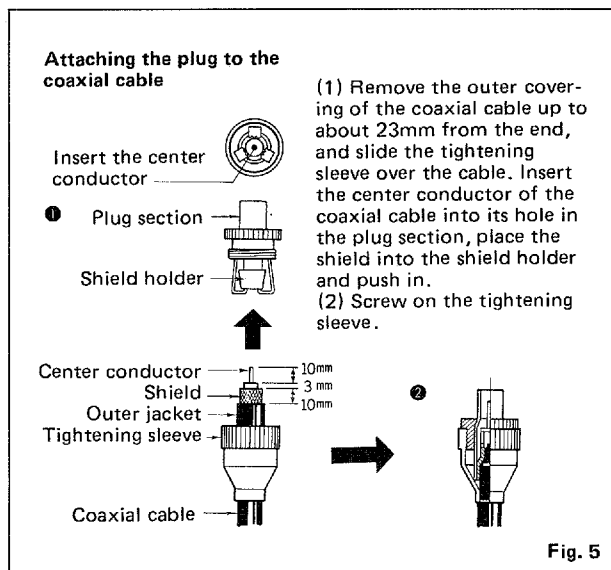

■ AC OUTLETS (U.S.A., Canadian and General models)

Provided for connecting other audio equipment. The left outlet, with a maximum power capacity of 200 W, is switched on and off by the receiver's power switch; right outlet is controlled by power switch on connected equipment, and with a maximum capacity of 200 W.

■ DIN CONNECTOR (North European model)

This socket accepts five-pin DIN plug for instant connection of tape deck for both recording and playback operations, if your deck also has an identical connector. Do NOT use DIN connector and the TAPE PB/REC OUT pin jacks at the same time.

■ VOLTAGE SELECTOR (General model)

Set this to your local AC mains voltage. Failure to do so will result in seriously impaired performance or even severe damage.

■ ALLEN WRENCH

An allen wrench is provided for use in removing or replacing the Input Selector knob.

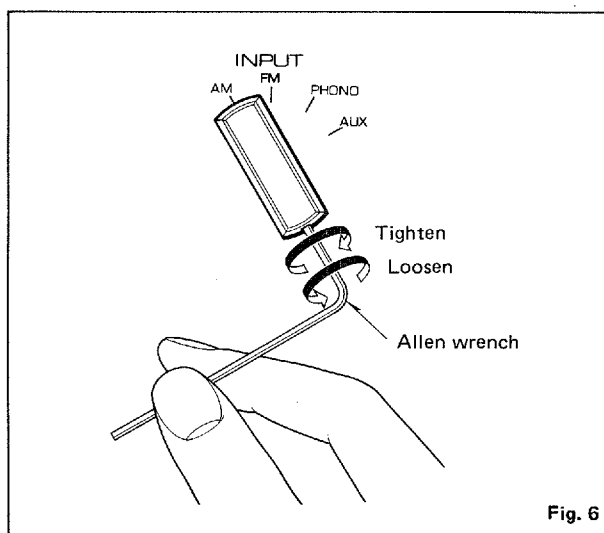

R-300 FRONT PANEL PARTS AND FUNCTIONS

FRONT PANEL

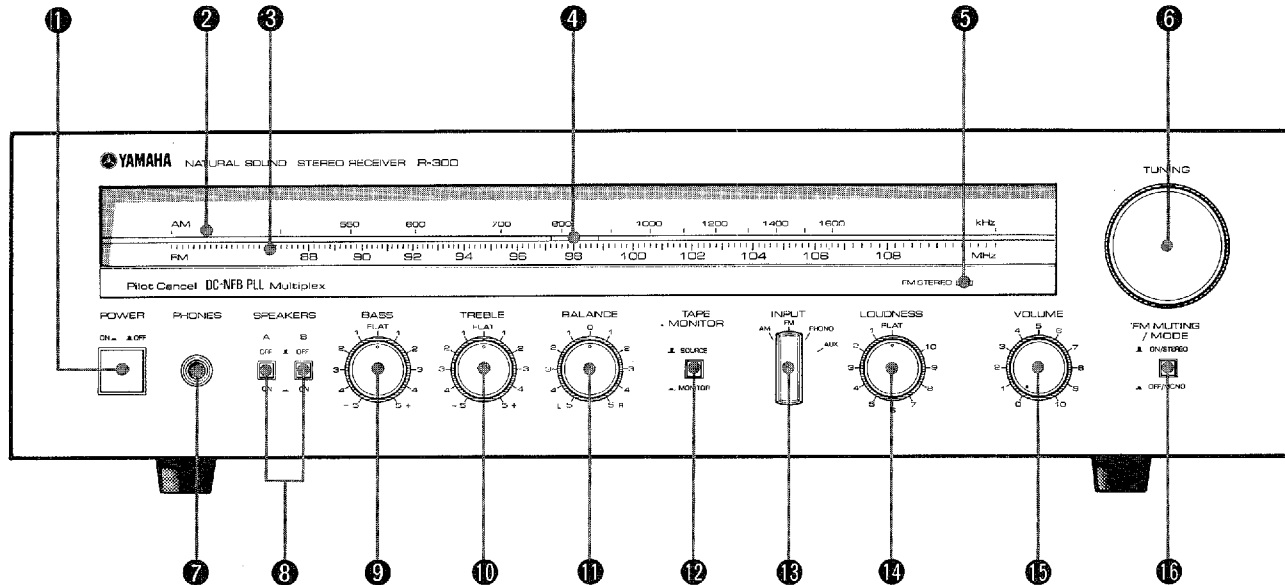

1 POWER SWITCH

This is a "push-on, push-off" type power switch. When power is turned on the tuning indicator and the dial illumination lamps will light.

2 AM DIAL SCALE

This is used for AM tuning and displays the frequency of the received AM station in kHz.

3 FM DIAL SCALE

This is used for FM tuning and displays the frequency of the received FM station in MHz.

4 TUNING INDICATOR

Rotate the tuning knob until this indicator is lined up with the frequency of the station to be tuned in. When tuning in an FM station, perfect tuning is indicated by both green LEDs lighting up with equal brightness.

* When the received signal is weak (below the muting level) the tuning indicator will not operate.

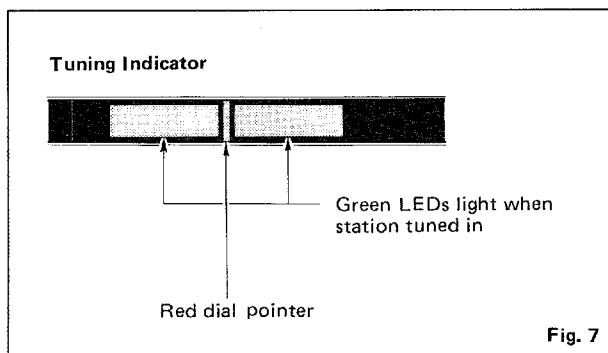

5 FM STEREO INDICATOR

When a received FM station is in stereo this indicator automatically lights, while on mono broadcasts it is unlit.

* When the FM Muting/Mode switch is in the Off/Mono () position the indicator will not light.

6 TUNING KNOB

This knob is used to tune in stations. Rotate the knob while observing the tuning indicator, observing for best reception.

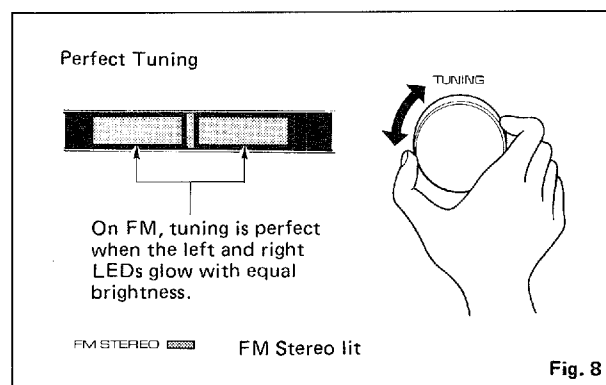

7 PHONES JACK

Used for plugging in headphones. When it is desired to listen to headphones only, Speaker switches A and B should both be set to the Off () position.

8 SPEAKERS SWITCHES

With these switches, you can select either or both of two sets of speakers.

9 BASS CONTROL

Used to control the bass response. A flat response is obtained at the Flat position. The bass effect is emphasized when the control is rotated to the right and attenuated when rotated to the left.



10 TREBLE CONTROL

Used to control the treble response. A flat response is obtained at the Flat position. The treble effect is emphasized when the control is rotated to the right and attenuated when rotated to the left.

11 BALANCE CONTROL

This control lets you adjust the relative volume of the left and right speakers, enabling you to compensate for unbalance caused by installation locations of the speakers and furniture arrangement.

12 TAPE MONITOR SWITCH

On tape playback this switch should be set to Monitor (); otherwise it should be set to Source ().

13 INPUT SELECTOR

Selects the program source to be listened to.



14 LOUDNESS CONTROL

Boosts the extreme low and high frequencies to compensate for our ear's reduced sensitivity to these frequencies at low volume. Set it to the Flat position while the Volume control is set to your normal listening level. Turning it counter-clockwise will reduce the volume while retaining the natural balance of the low and high frequencies.

15 VOLUME CONTROL

Used to adjust overall sound volume.

16 FM MUTING/MODE SWITCH

Turning this switch on () activates the muting circuit and silences the noise that would otherwise be heard between FM stations. When the received station is very weak, however, it too will be silenced. Therefore, when you want to listen to a very weak station, the switch should be set to the Off/Mono () position.

* In the Off/Mono position, even FM stereo broadcasts will be heard in mono.

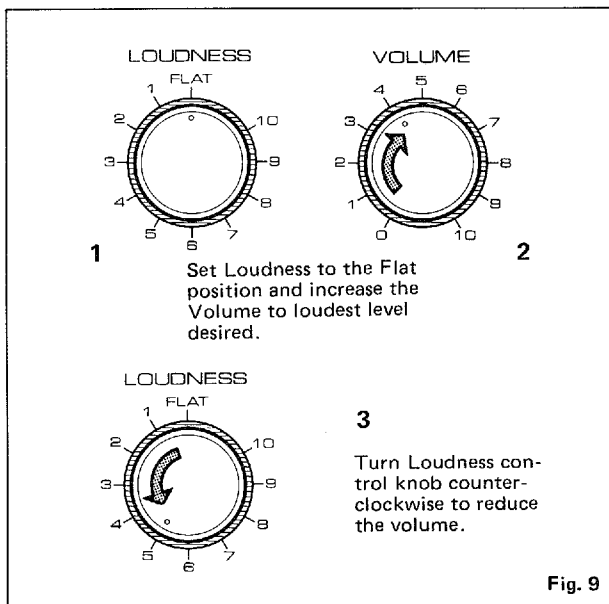

R-300 LISTENING TO A PROGRAM SOURCE

■ LISTENING TO FM BROADCASTS

1. Set the Input selector to FM.
2. Set the Tape Monitor switch to Source (■).
3. Next, set the FM Muting/Mode switch to On/Stereo (■).
4. Rotate the tuning knob so that the tuning indicator lines up with the frequency of the desired station. Adjust so that both of the tuning indicator green LEDs light with equal brightness. If one of the green LEDs is dim or unlit, rotate the tuning knob in the direction of the dark LED.

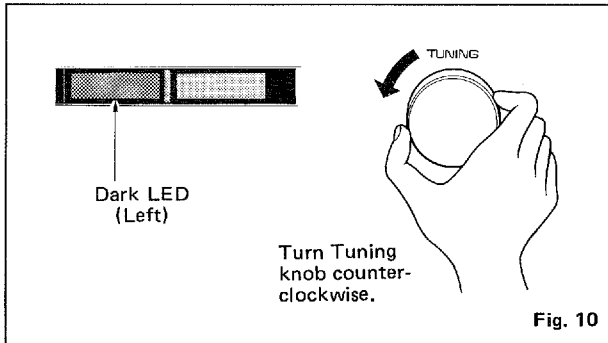

When a received FM station is in stereo FM Stereo indicator automatically lights, while on mono broadcasts it is unlit.

- * When listening to a weak, distant station or when there is interference from another station, setting the FM Muting/Mode switch to the Off/Mono (■) position will cause the station to be received in mono and considerably reduce noise.
5. Adjust the volume level and listen to the station.

■ LISTENING TO AM BROADCASTS

1. Set the Input selector to AM.
2. Set the Tape Monitor switch to Source (■).
3. Rotate the tuning knob so that the tuning indicator lines up with the frequency of the desired station. Adjust so that both of the tuning indicator green LEDs light with maximum brightness.
4. Adjust the volume level and listen to the station.

■ LISTENING TO RECORDS

1. Set the Input selector to Phono.
 2. Set the Tape Monitor switch to Source (■).
 3. If your turntable is equipped with an MM cartridge it can be connected directly to the receiver, but if an MC cartridge is used an MC cartridge head amp or a step-up transformer will be necessary.
 4. Place a record on the turntable and start it playing.
 5. Adjust the volume level and listen to the record.
- * When lowering the stylus to the record or raising the stylus from the record, turn the volume control all the way to "0".

■ RECORDING TAPES

1. Set the Input selector to the source to be recorded.
 2. Start the music from the selected source.
 3. Set the recording level, etc. of the tape deck, and begin recording.
 4. If your tape deck has three heads, setting the R-300's Tape Monitor switch to the Tape Monitor (■) position will allow you to monitor the recorded material.
- * Adjusting the tone controls (Bass, Treble) or the volume control during recording has no effect on the material being recorded.

■ PLAYING BACK TAPES

1. Set the Tape Monitor switch to the Tape Monitor (■) position.
2. Set the tape deck to Play.
3. Adjust the volume control and listen to the tape.

R-300 TROUBLESHOOTING

Before assuming that your receiver is faulty, check the following troubleshooting list which details the corrective action you can take yourself without having to call a service engineer. If you have any doubts or questions, get in touch with your nearest Yamaha dealer.

	FAULT	CAUSE	CURE
AUDIO	Power is not applied even though the Power switch is turned on.	The power cord is not plugged in.	Plug in the power cord.
	There is no sound with any position of the Input selector.	The Speakers switches are not set correctly.	Set them correctly.
		The input cords are not connected securely.	Plug them in securely.
		The Tape Monitor switch is set to Monitor.	Set the switch to Source except for the tape playback.
	There is no sound from one speaker.	The speaker connections are not secure.	Secure the connections.
		The Balance control is set all the way to the left or right.	Adjust the Balance control correctly.
	There is a lack of bass and no ambience.	The + and - cords have been reversed at the amp or the speakers.	Connect the speaker wires in the correct phase (+ and -).
	There is a humming sound when playing records.	The input cords are not connected securely.	Plug the input cords in securely.
		The turntable's ground wire is not connected.	Connect the ground wire.
	There is a howling sound when playing records at high volume.	The turntable and the speakers are too close together or the turntable is not mounted on a firm surface.	Change the location of the turntable or the speakers.
FM	Crackling sounds from time to time (especially in weak signal areas).	Ignition noise from vehicles.	The FM antenna should be put up as high as possible, away from the road, and a coaxial cable used.
		Noise from thermostats and other electrical equipment.	Attach a noise suppressor to the equipment causing the noise.
	The FM stereo reception is noisy.	Because of the characteristics of FM stereo broadcasts, this is limited to cases where the transmitter is far away or the antenna input is poor.	Check the antenna connections. Try using a multiple element FM antenna.
	The FM Stereo indicator flickers on and off and reception is noisy.	Insufficient antenna input.	Use an antenna appropriate for the reception conditions in your area.
		Not tuned correctly.	Tune again.
	There is distortion and clear reception cannot be obtained even with a good FM antenna.	There is multipath interference.	Adjust antenna placement to eliminate multipath interference.
No stereo effect even with a stereo broadcast.	The FM Muting/Mode switch is set to Off/Mono.	Set the FM Muting/Mode switch properly.	
AM	Insufficient sensitivity.	Weak signal or loose antenna connections.	Tighten the AM loop antenna connections and rotate it for best reception. Use an outdoor antenna.
	There are continuous crackling and hissing noises.	These noises result from lightning, fluorescent lamps, motors, thermostats and other electrical equipment.	Use an outdoor antenna and a ground wire. This will help somewhat but it is difficult to eliminate all noise.
	There are buzzing and whining noises.	Another station is interfering with the received station.	This is impossible to remedy.
A television set is being used nearby.		Move the television a distance away.	

R-300 SPECIFICATIONS

AUDIO SECTION

Continuous Output Power Per Channel (IHF)	
20Hz ~ 20kHz (0.015% THD, 8Ω)	30W (14.8 dBW)
1kHz (0.01% THD, 8Ω)	35W (15.4 dBW)
DIN Standard Output Power Per Channel	
1kHz (1% THD, 8Ω)	36W (G)
Power Bandwidth	
0.02% THD, 15W (8Ω)	10Hz ~ 40kHz
Damping Factor (at 1kHz, 8Ω)	
	better than 40
Input Sensitivity/Impedance	
Phono	2.5 mV/47 kΩ, 220pF
	2.5 mV/47 kΩ, 470pF (G)
Aux, Tape	120 mV/47 kΩ
DIN terminal	120 mV/45 kΩ (G)
Input Sensitivity (New IHF)	
Phono	0.46 mV
Aux, Tape	22 mV
Maximum Input Level (0.01% THD)	
Phono 20Hz ~ 20kHz	150 mV
1 kHz	180 mV
Output Level/Impedance	
Rec Out (Phono)	120 mV/470Ω
DIN Out	28 mV/52 kΩ (G)
Headphone Jack Rated Output/Output Impedance	
0.015% THD	0.54 V/220 Ω
Frequency Response	
Aux, Tape	10Hz ~ 100kHz -1dB
Total Harmonic Distortion (20Hz ~ 20kHz)	
Phono (3V)	0.005%
Aux, Tape to Sp Out (1W/8Ω)	0.005%
Intermodulation Distortion	
Aux, Tape Rated output/8Ω	0.01%
1W/8Ω	0.015%
Signal-to-Noise Ratio (IHF-A Network)	
Phono (5mV, Input shorted)	85 dB
	75 dB (G)
Aux, Tape (Input shorted)	100 dB
	100 dB (G)
Signal-to-Noise Ratio (New IHF)	
Phono	74 dB
Aux, Tape	82 dB
Tone Control Characteristics	
Bass boost/cut	± 10 dB (at 50 Hz)
Bass turnover frequency	350 Hz
Treble boost/cut	± 10 dB (at 20 kHz)
Treble turnover frequency	3.5 kHz
Continuous Loudness Control	
(Level-related equalization)	
Maximum attenuation	-20 dB (at 1 kHz)
Rec Output Level/Impedance (Fixed)	
FM (100% Mod. 1 kHz)	500 mV/4.4 kΩ
AM (30% Mod. 1 kHz)	150 mV/4.4 kΩ

FM SECTION

Tuning Range	87.6 ~ 108 MHz
50 dB Quieting Sensitivity	
Mono	3.0 μV (14.8 dBf)
Stereo	40 μV (37.3 dBf)
Usable Sensitivity (IHF Mono, 1 kHz 100% Mod.)	
300 Ω	1.8 μV (10.3 dBf)
75 Ω	0.9 μV (10.3 dBf)

Usable Sensitivity (DIN, 40 kHz Dev.)

Mono (S/N 26 dB)	1.2 μV (G)
Stereo (S/N 46 dB)	28 μV (G)
Image Response Ratio	50 dB
IF Response Ratio	90 dB
Spurious Response Ratio	70 dB
AM Suppression Ratio (IHF)	60 dB
Capture Ratio	1.5 dB
Alternate Channel Selectivity	55 dB
Signal-to-Noise Ratio (IHF)	
Mono	84 dB
Stereo	80 dB
Harmonic Distortion	
Mono 100 Hz	0.1%
1 kHz	0.1%
6 kHz	0.15%
Stereo 100 Hz	0.2%
1 kHz	0.2%
6 kHz	0.3%
IM-Distortion (IHF)	
Mono	0.1%
Stereo	0.2%
Stereo Separation	
50 Hz	30 dB
1 kHz	40 dB
10 kHz	30 dB
Frequency Response	
50 Hz ~ 10 kHz	± 0.3 dB
30 Hz ~ 15 kHz	+0.5 -1.5 dB
Sub-carrier Product Ratio	45 dB
Muting Threshold	3μ V (14.8 dBf)
Blend Switching Threshold	30μV (34.8 dBf)

AM SECTION

Tuning Range	525 ~ 1605 kHz
Usable Sensitivity (IHF, Loop Ant.)	300 μV/m
Selectivity (± 10 kHz)	30 dB
Signal-to-Noise Ratio	50 dB
Image Response Ratio	40 dB
Spurious Response Ratio	50 dB
Harmonic Distortion (1 kHz)	0.4%

GENERAL

Semiconductor	24 Transistors 10 ICs, 1 FET 4 LEDs, 22 Diodes
Power Supplies	
USA and Canadian models	AC120V, 60 Hz
North European model	AC220V, 50Hz
British and Australian models	AC240V, 50Hz
General model	AC110/120/220/240V 50/60 Hz
Power Consumption	
USA and Canadian models	130W
North European, British and Australian models	180W
General model	70W
Dimensions (W x H x D)	435 x 122 x 337 mm (17-1/8 x 4-3/4 x 13-1/4 in)
Weight	7.7 kg (16.94 lbs)

* (G) North European model only
Specifications subject to change without notice.

R-300 BLOCK DIAGRAM

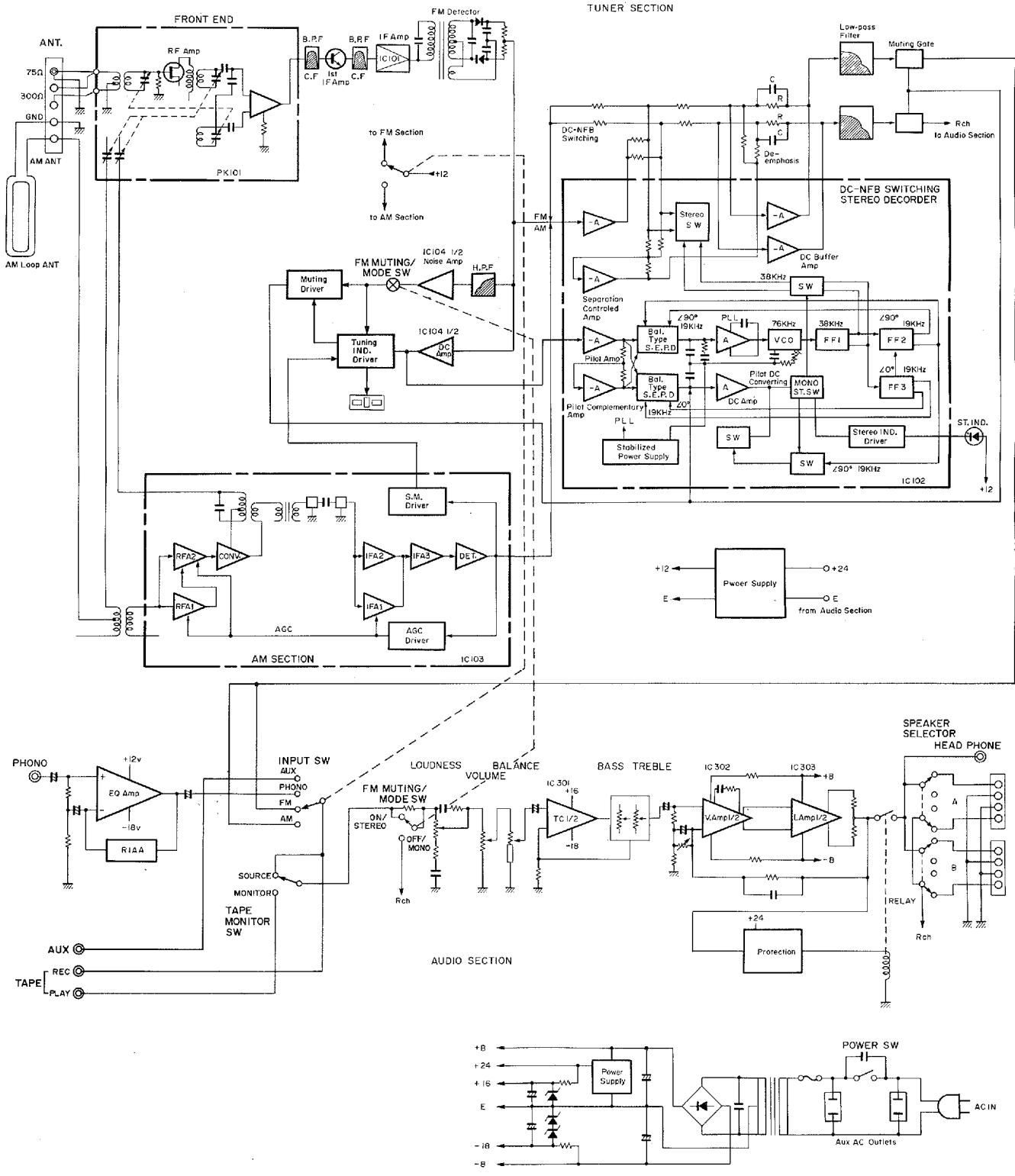

SINCE 1887  **YAMAHA**
NIPPON GAKKI CO., LTD. HAMAMATSU, JAPAN